

Mark Davidson's

Earthshaker Moving Institute Kit

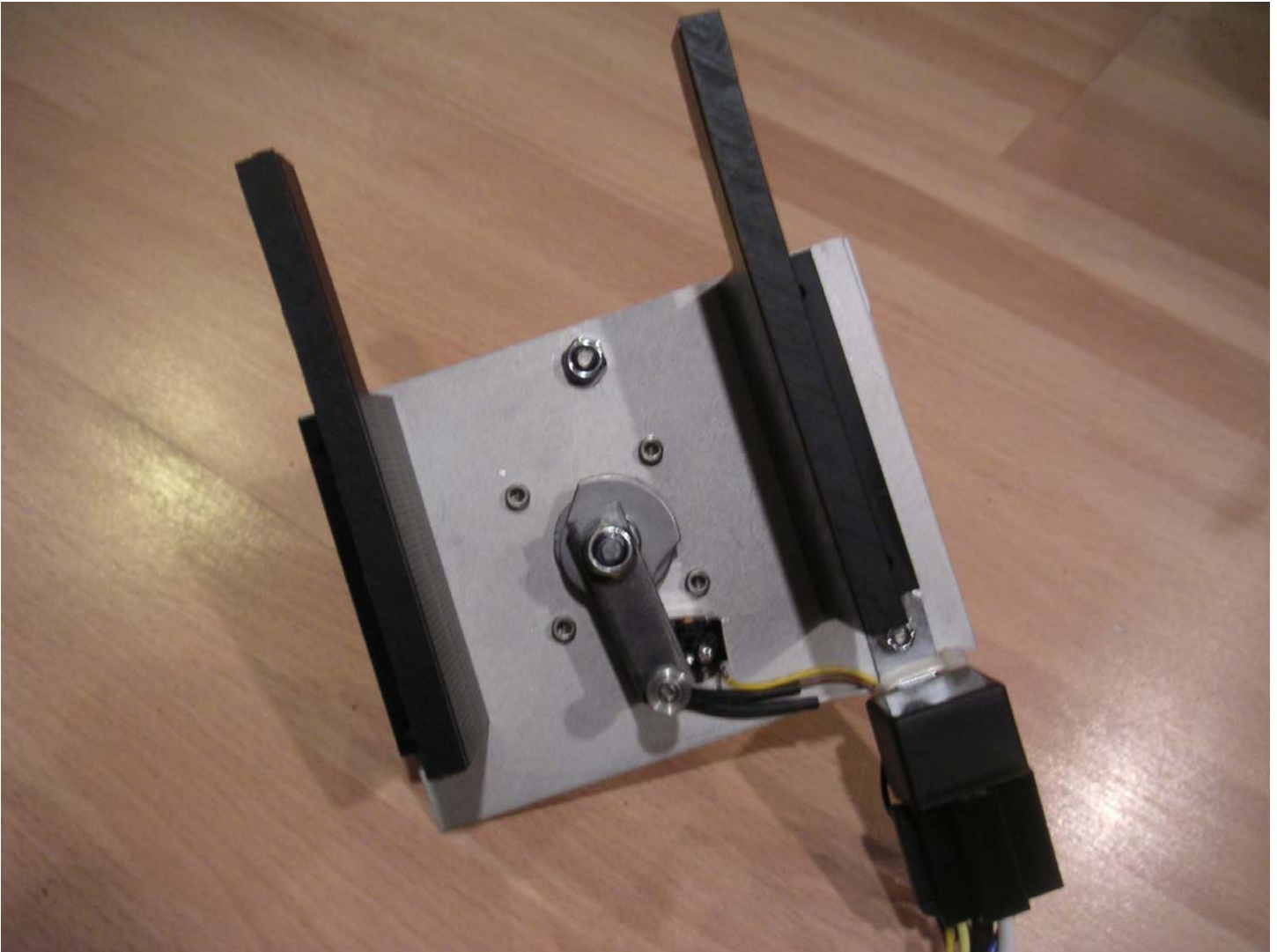

An upgrade for Williams' 1989 Earthshaker Pinball Machine

Final Documentation ©2007 by Al Warner in association with BA Associates

Notice Regarding this Upgrade

WARNING!

Although this upgrade has been tested and the equipment used will not directly cause harm to your pinball machine, if you do something wrong you can seriously damage the game electronics.

To perform this upgrade you should:

- Be familiar with safe handling procedures for electronic components.
- Be able to use hand tools such as a drill and screwdriver.
- Be able to follow directions.

Pinball machines are designed to be serviced and are subsequently well built, but by modifying any device you accept the risk that you may break something.

PLEASE READ THESE INSTRUCTIONS COMPLETELY THROUGH BEFORE STARTING. If you are like us, you probably downloaded the instructions from the internet before your kit arrived. Good Move!

All attempts have been made to make this an easy and clean install but please note that all machines and parts were not made exactly the same way. It is possible that you will need to modify your machine to properly install the ES Kit. We will inform you of any inconsistencies that we have found to help the process along.

I make no warranties on the ES Kit, expressed, implied, statutory, or in any other communications with you. I specifically disclaim any implied warranty of merchantability or fitness for a particular purpose, I do not warrant that the operation of the ES Kit will be uninterrupted or error free. In no event will I or any supplier be liable to you or any other person for any damages, including any incidental to consequential damages, expenses, lost profits, lost savings, or other damages arising out of the use of or inability to use the ES Kit even if I have been advised of the possibility of such damages.

Please understand that the ES Kit was created for collectors to add a feature that was removed from the original game. I want nothing more than for you to enjoy the upgrade and this project was originally created to build one for myself. Please remember that this is a hobby for me and I'll try to help you with any problems as they arise but I may not be able to give you exactly what you want. E-mail me at mark@basementarcade.com if there are any questions. Questions regarding the documentation should be directed to al@pinballobsession.com.

Many of the pictures used in this manual were taken during the development phase. Subsequently, there may be some variations between our pictures and your unit but they will not affect your unit's performance (ours has LOTS of extra holes and stuff from development). We used a spare red Institute that was pretty beat up for much of the manual. Our good one was already installed in our machine.

Thanks to Clay Cowgill for his disclaimer, it saved us a ton of research.

Introduction

Thank You for purchasing the ES Kit. We think you will enjoy it. The kit is as easy to install as we could make it.

Terms Used

The cabinet portion containing the circuit boards is the **Backbox**. The red frame containing the lights is the **Institute**. The **Institute Track** is molded into the back bottom of the institute. The **Motor Unit** is the mechanism that moves the institute. The **Black Rails** are attached to the motor unit and provide a track for the Institute to ride in. The **Cam Follower** is a roller attached to the steel bar on the motor unit.

Inventory

The Earthshaker Kit includes:

Qty	Item
1	Earthshaker Motor Unit
1	Wiring Harness
2	Washers
1	Installation Manual

Tools Required

Drill with 1/8" bit, Phillips Screw Driver, Strong Hands, 1/4" Nut Driver or Wrench, Allen Wrench Set

Preparation

Remove your playfield lockdown bar, and playfield glass. Raise the playfield. Locate the two ¼" screws marked below.

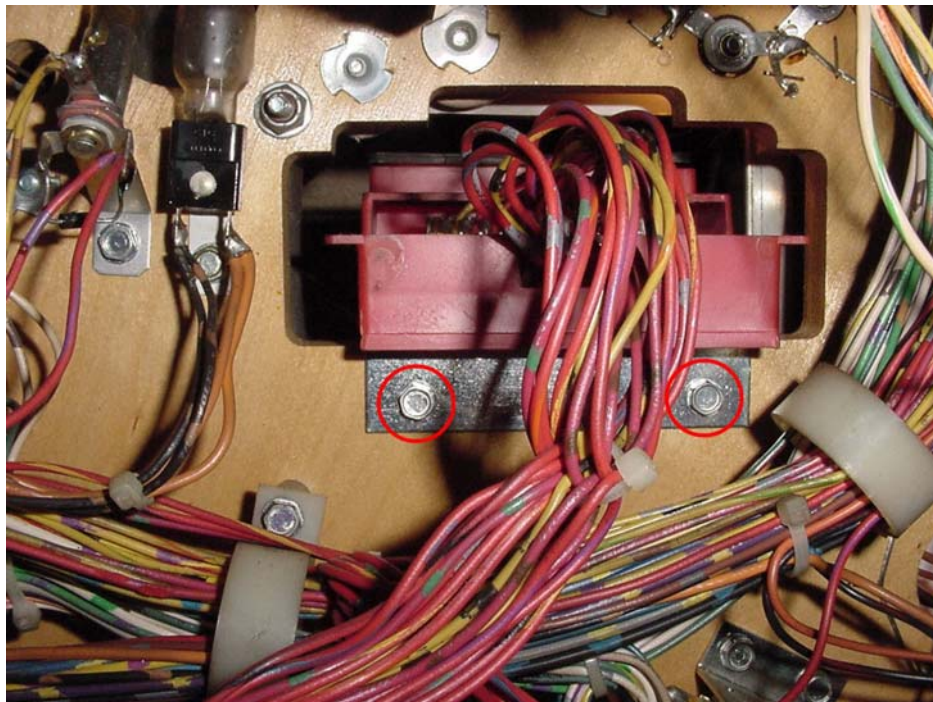

Carefully remove the wire connector from the bottom of the institute. Use a ¼" nutdriver or a small ratchet to remove the screws. Retain the screws to later install the motor unit.

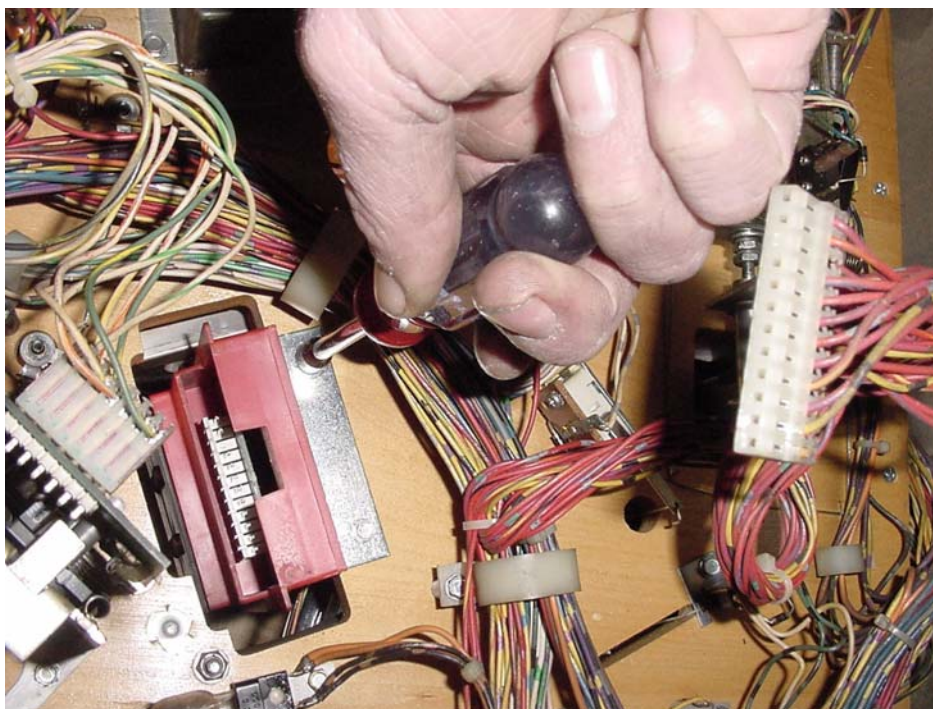

Lower the playfield and carefully remove the institute from the top.



You will encounter some resistance as you remove the institute because the metal bracket will rub, but jiggling it a bit will get it out.



You have just created a gaping hole in your game!



Move the institute to a clean static free place. Locate the two screws that hold the lamp PCB to the institute's plastic frame. Remove these screws with a philips screw driver.

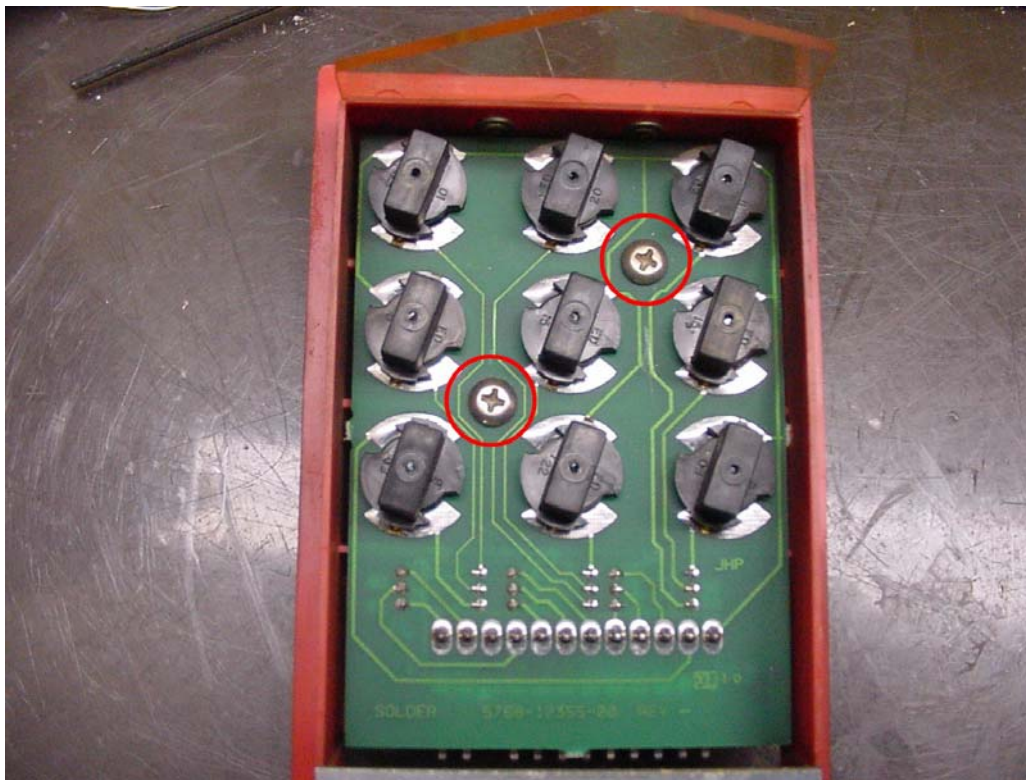

We are now going to have to remove the two rivets shown below to remove the mounting bracket.



This process requires extra care to properly accomplish without damaging the institute frame. Use a 1/8" drill bit with a variable speed drill (if you have one) and carefully center the bit on the rivet as shown below



Slowly drill the rivet out. The rivet will be stuck on the end of the drill bit when you complete it. It is important that you take your time with this.



If you did this right, you now have some souvenir washers and the institute looks as shown.

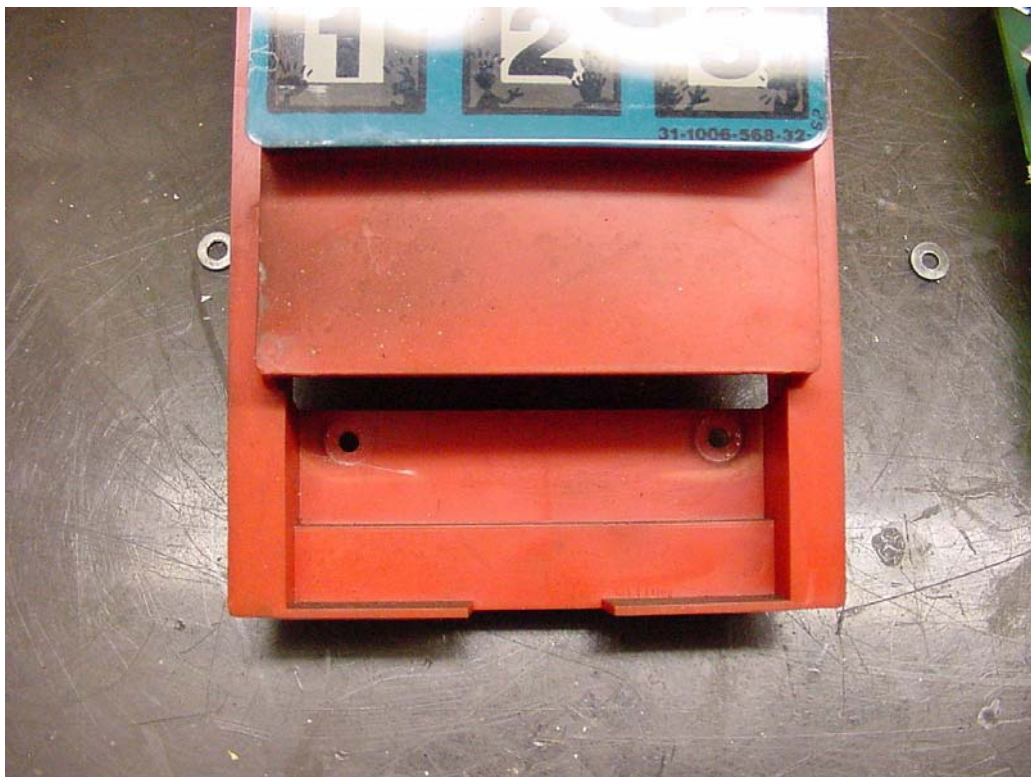

Repeat the process for the two rivets holding the ball guard on at the top of the institute as shown.



Two more souvenir washers and the institute is ready to be assembled. Be sure to hold on to the removed parts should you wish to reverse the installation. Also, this is a great time to pull out the Novus and give that institute a nice polishing!



Installation

Replace the lamp PCB on the back of the institute frame and secure it with the two screws.

Place the motor unit face down on a work surface as shown and remove the two bolts (shown below) holding the left black track on the unit with an allen wrench.

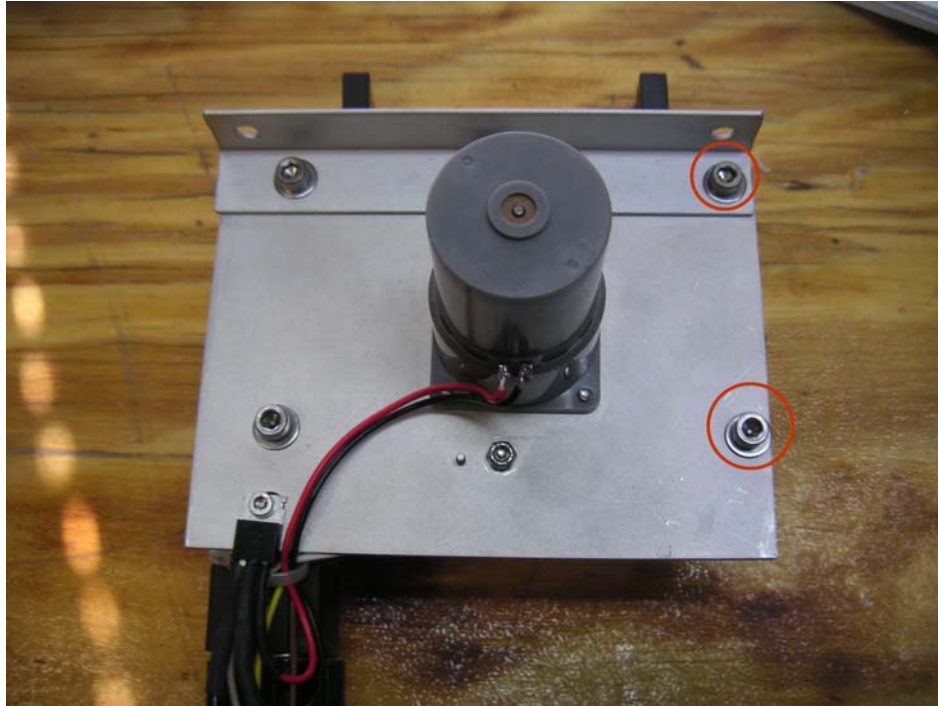

You should now see about the same thing as the picture shown below.



When we install the Institute in the side tracks, we will need to align the cam follower with the institute track. This picture does not show how it is mounted, it just shows where the cam follower rides.



Align the cam follower on the institute track and insert the institute in the right black track.

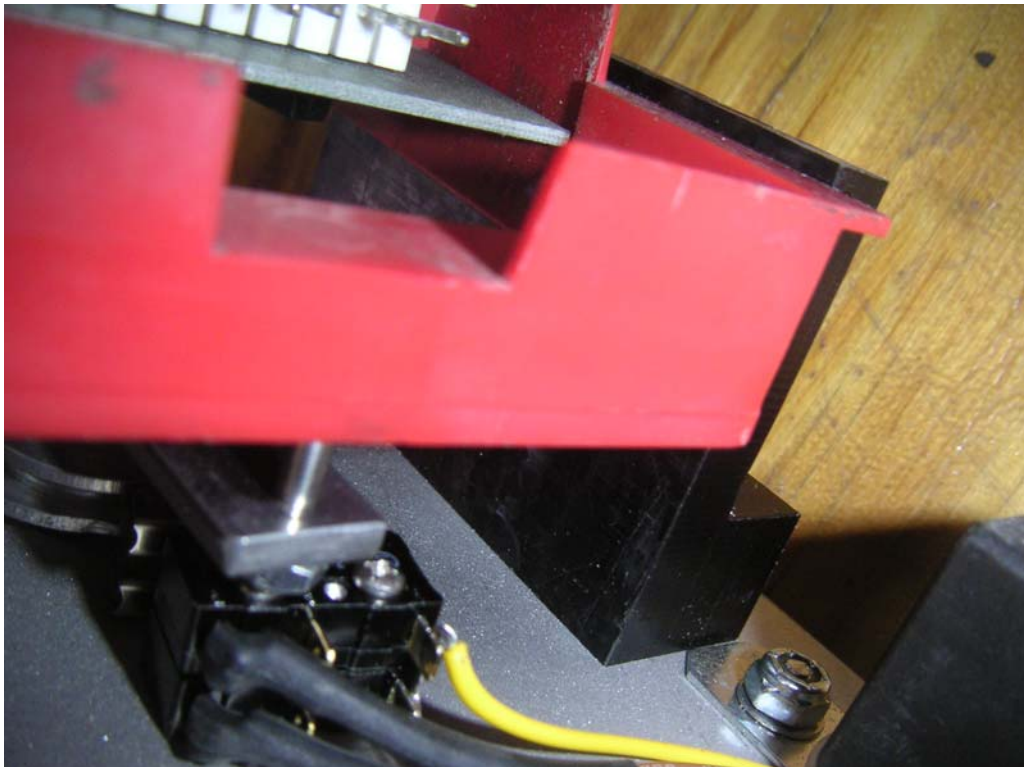

Replace the left black track and align the institute so it is in the groove of the track as shown below.

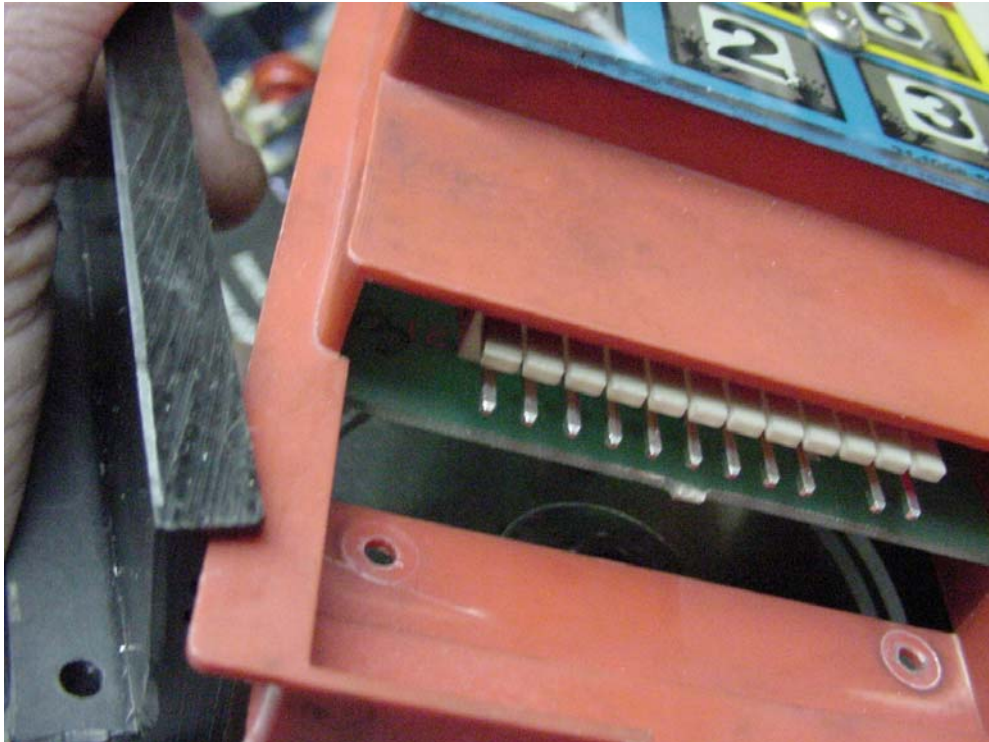

Squeeze the tracks and replace the screws to hold the institute between the black tracks.



If you got it right, the institute is between the two black tracks and the cam is in the institute's track as shown below. Set the unit aside for now.

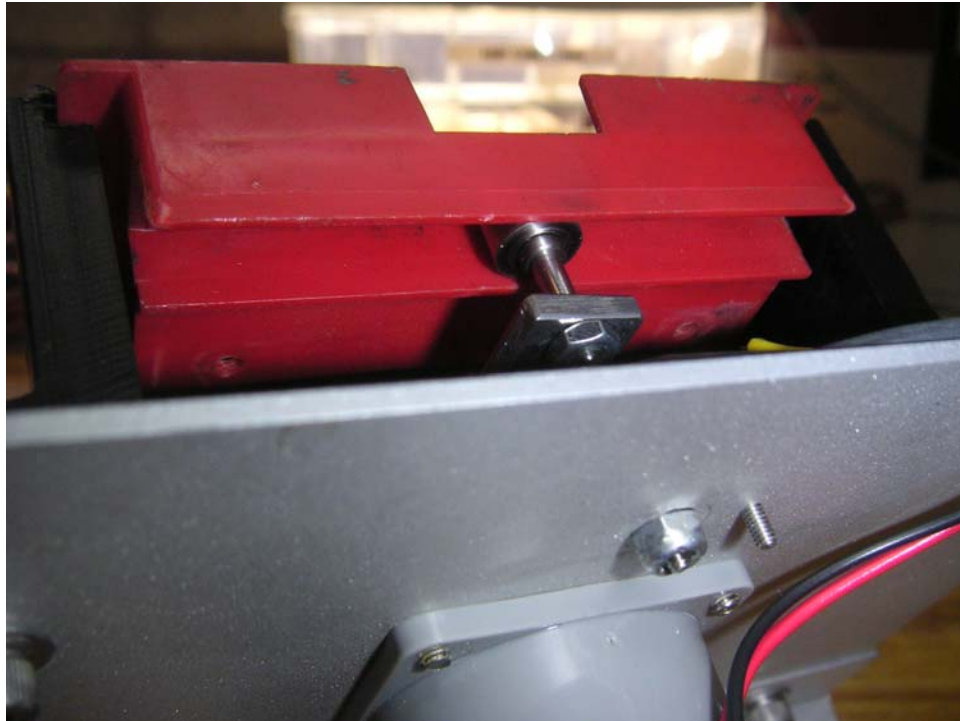

Locate connector J12 on the interconnect board in the backbox and carefully remove the connector. Insert the matching connector of the enclosed wiring harness in place of the connector you removed. It will only fit one way as shown below.

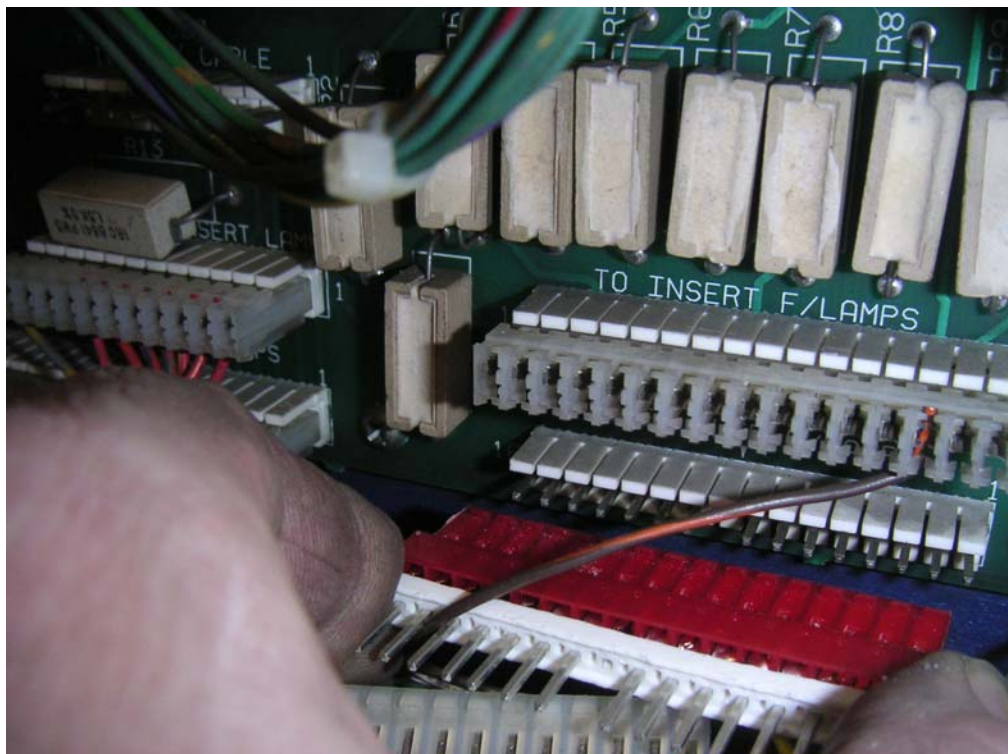

Replace the original connector on the pins we provided.

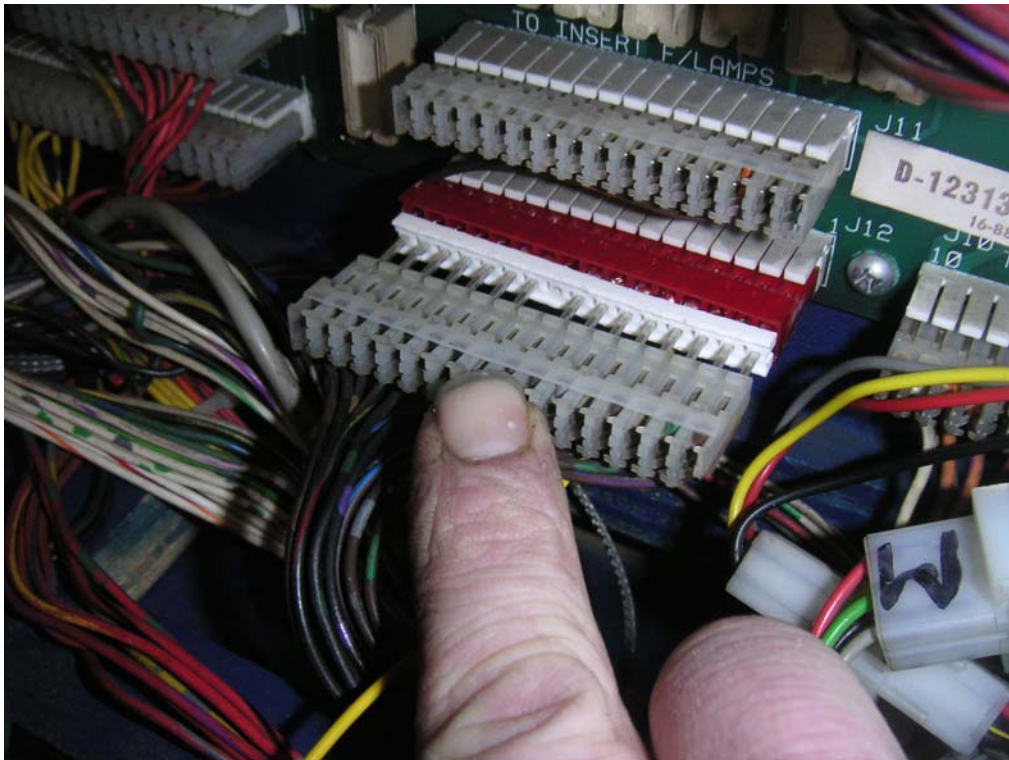

When installed, it should look like the following:

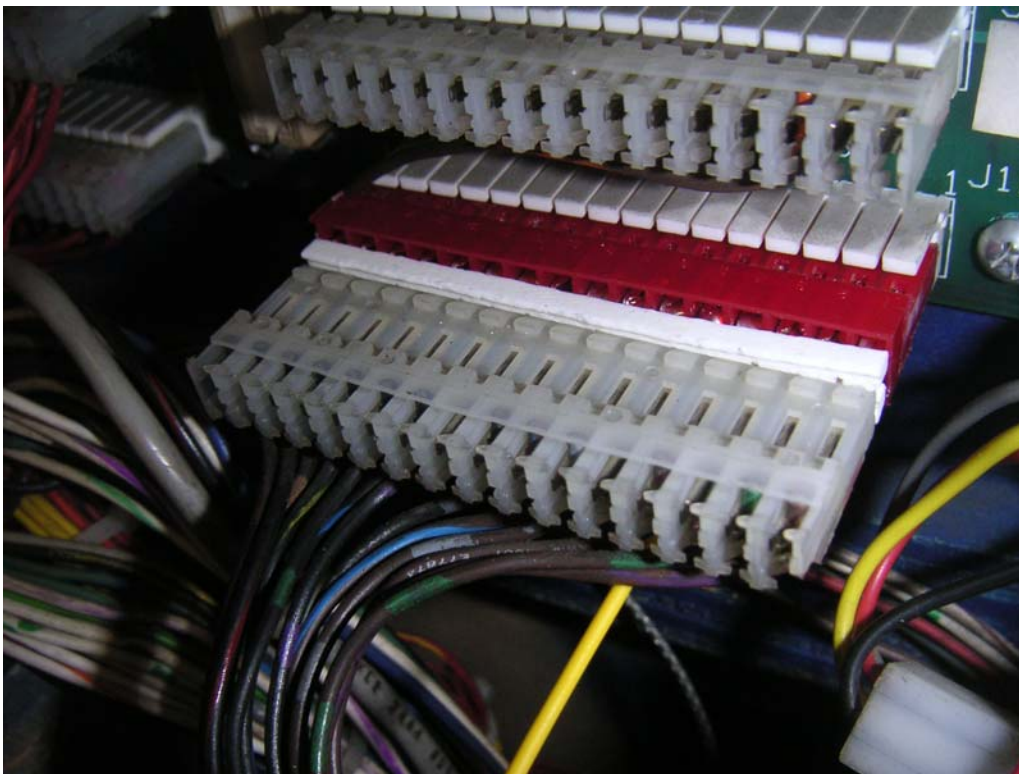

Repeat this process for connector J8 and J19 on the interconnect board.

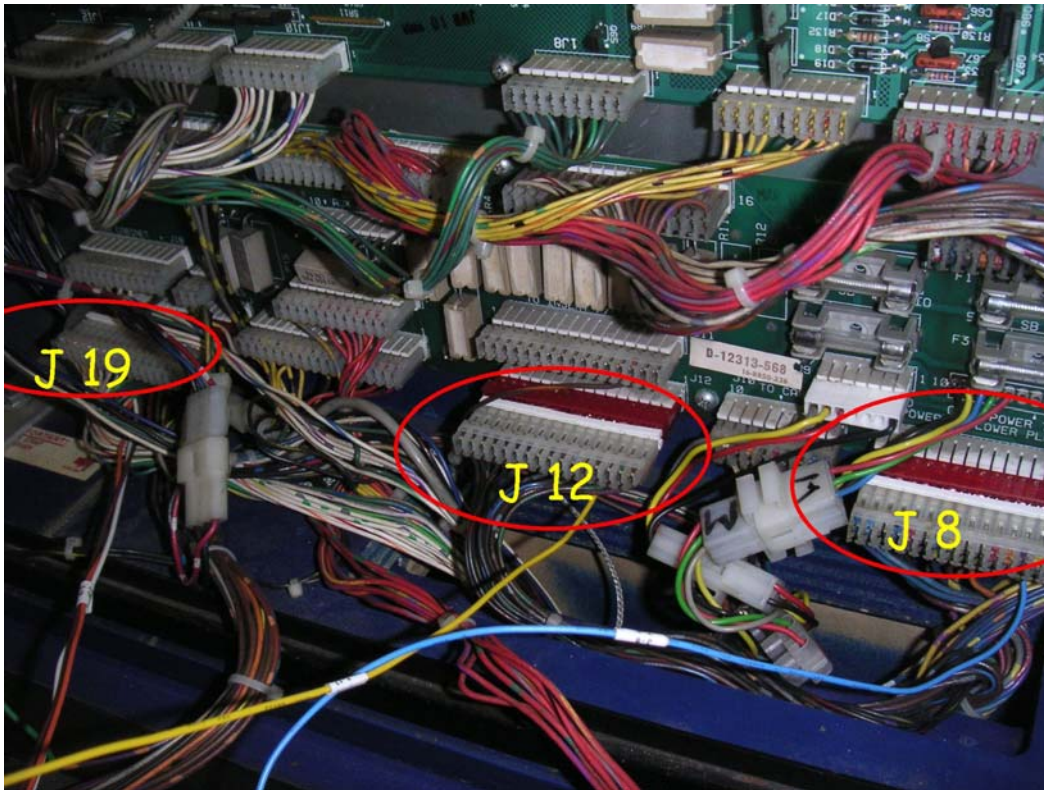

Plug J1 into your power board.

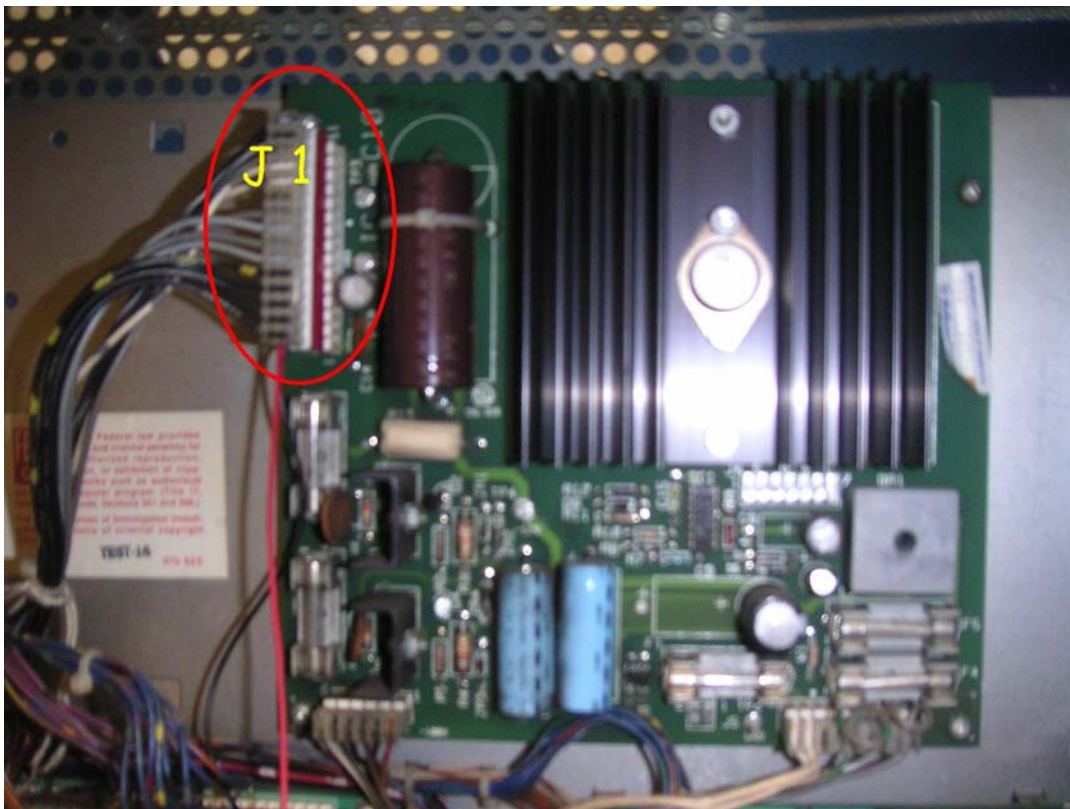

When complete, feed the wires through the backbox to the under side of the playfield. We are now going to test the unit. Connect the other end of the wiring harness to the motor unit.

Hold the assembly loosely in your hand and power up the game. The institute should reset automatically. The institute will bob up and down once or twice as the unit homes itself. Once it is home, the bearing will roughly sit between the 11:00 and 12:00 position. At full down, the cam sits at the 6:00 position.

Rotation of the motor should be counter clockwise and should never be reversed. You may also notice some side to side rocking of your institute as it reaches top dead center and starts it's decent. This is also normal and mimics the original unit.

Turn off the game.

The two wire clamps shown below must be removed to make room for our assembled unit and to add some additional wire slack; the building will need more wire as it travels. Use your 1/4" nut driver or ratchet to remove.

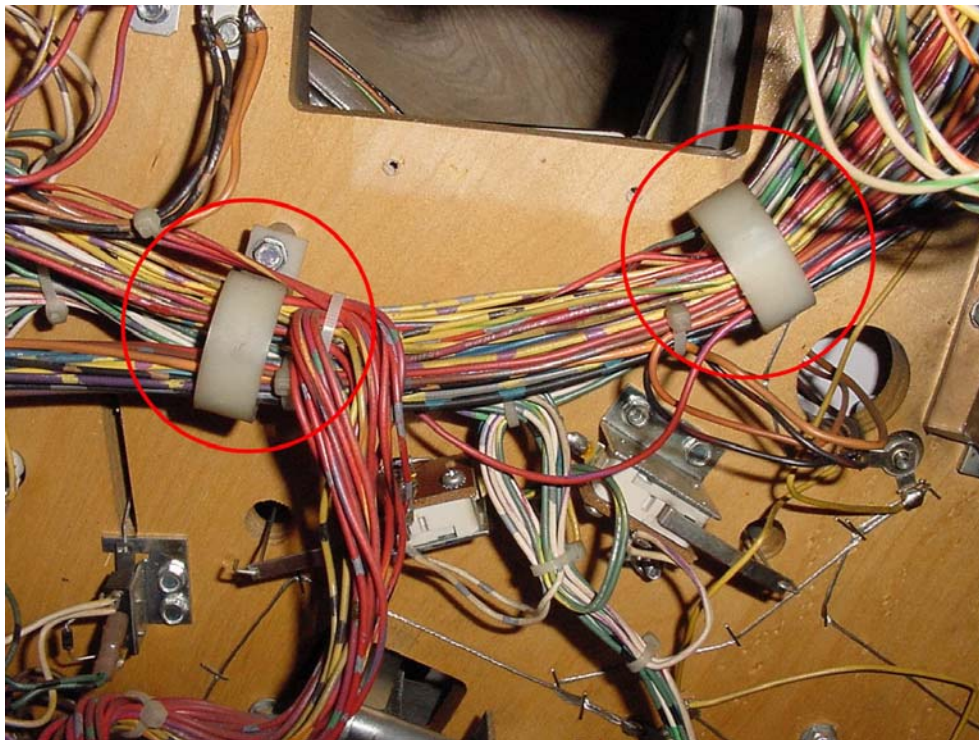

Place the institute in the hole as shown below.

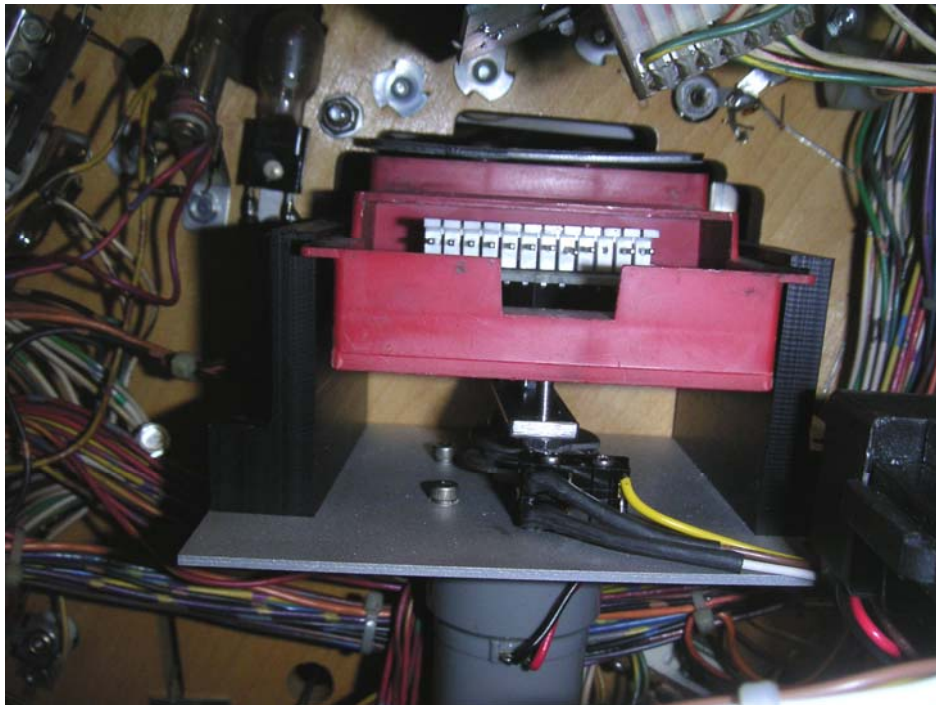

We have come across a potential problem with reproduction ramps. It appears that there is potential for the building to make contact with the lip of the ramps as shown below. Prior to securing the building to the playfield, confirm that when the building is fully raised that it will not contact the ramp. We have confirmed that production and prototype ramps were different, but when we built and tested the device it was done with original Williams production ramps and we did not have any clearance issues. It is possible that you will need to notch a reproduction ramp where the building would contact. If the building touches the ramp, it will most likely do permanent damage to the internal gears in the motor.



Your building should instead look like this:



Use the two screws we removed that held the institute in originally backed with the two washers we supplied, to secure the institute to the playfield. You will need push hard when inserting the screws so that they tap new holes in the underside of the playfield. You can drill pilot holes to make the process easier, but there is a danger of drilling through the playfield or catching some wires with the drill so we're leaving this to your discretion.

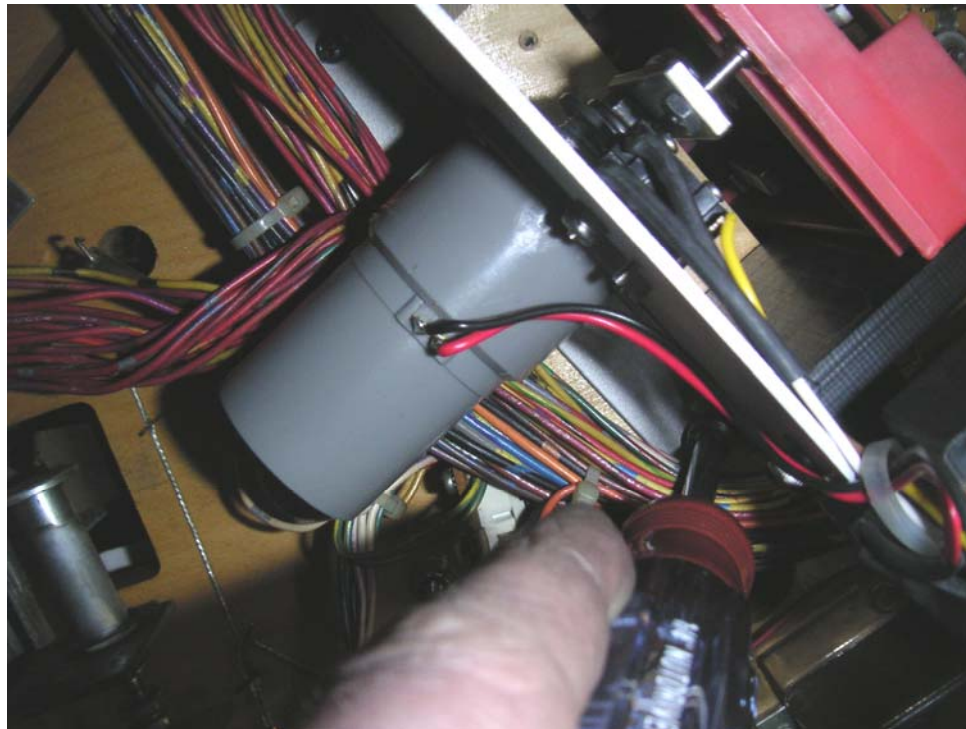

Replace the connector for the lights on the institute.

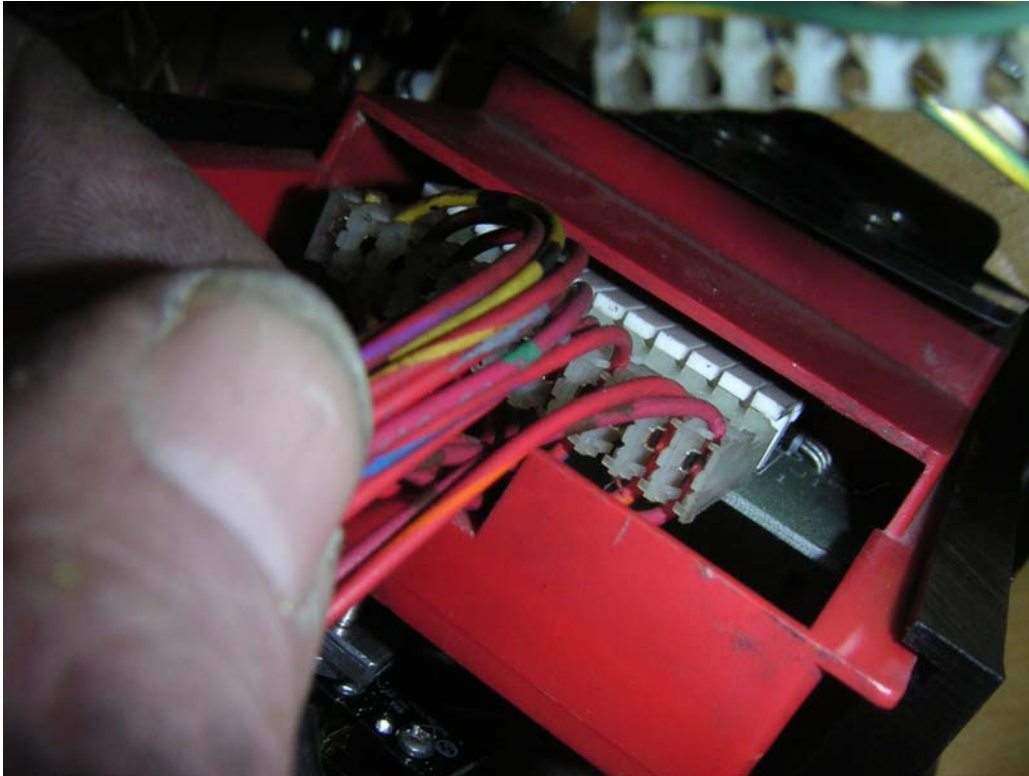

Lower the playfield and power up the machine.

Congratulations! Your unit is installed!



Appendix A – Troubleshooting

GAME REBOOTS WHILE PLAYING

The Earthshaker Kit gets its power from the 12 volt circuit that is located on your power board. Adding the ES Institute Kit to your game can cause stress to a circuit that never had it before. Details for repair can be found at: <http://www.pinrepair.com/sys11/index2.htm#reset> (link used with permission).

Appendix B – Maintenance

The Earthshaker Kit requires no maintenance. It was pre-lubricated before it was sent to you. Because it is made mostly of aluminum and stainless steel it should resist most obverse conditions. As with any device of this type it should be kept dry.

Appendix C – Adjustments

After evaluating the issues that our previous owners experienced, we built additional adjustability into the unit.

If you feel the need to adjust the fit of the building, start by adjusting the left side riser using the bolts circled below. The holes on the left side have the most amount of movement for adjustment .

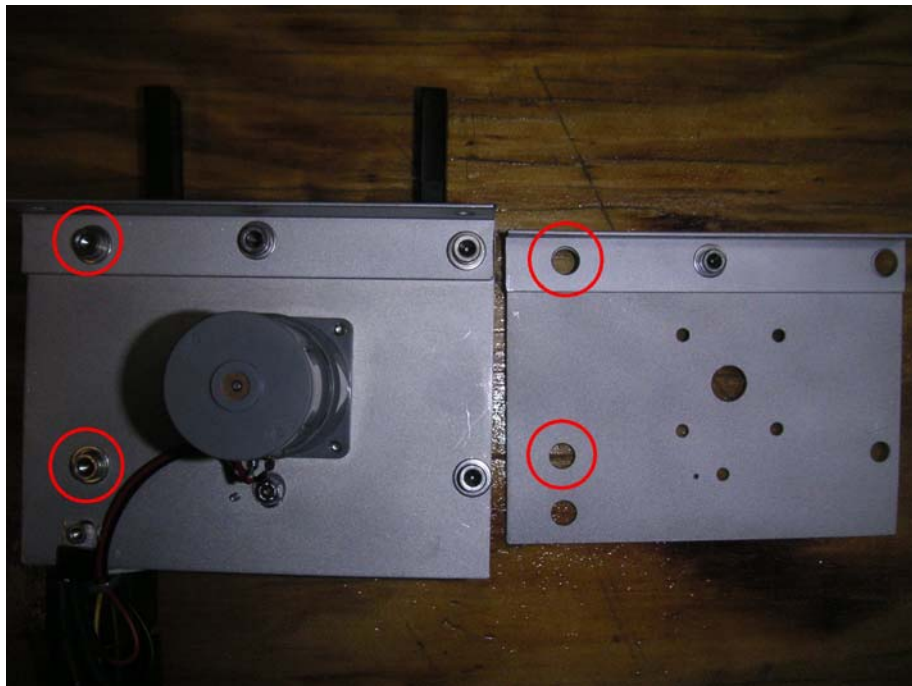

To reduce some of the building's wobble at its uppermost position, loosen the bolt circled in red below. The bolts circled in blue are pivot points and are not used for fit adjustment

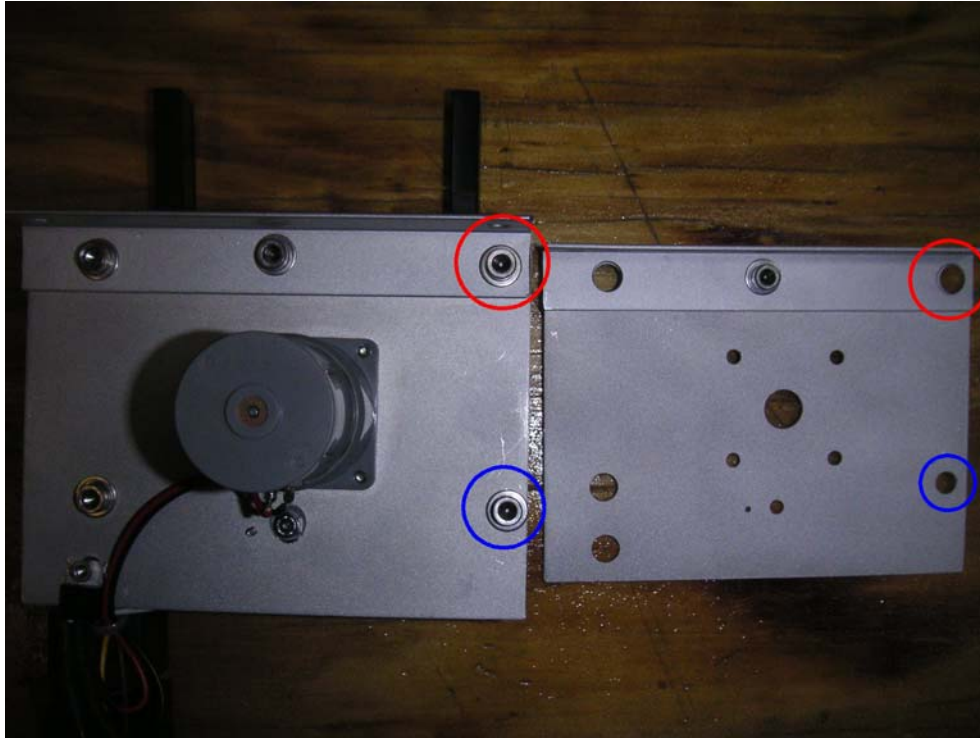

Be careful when adjusting the rails not to get too close to the Cam Follower. Contact between the cam follower and the risers will damage the unit so be careful not to adjust the riser too close.

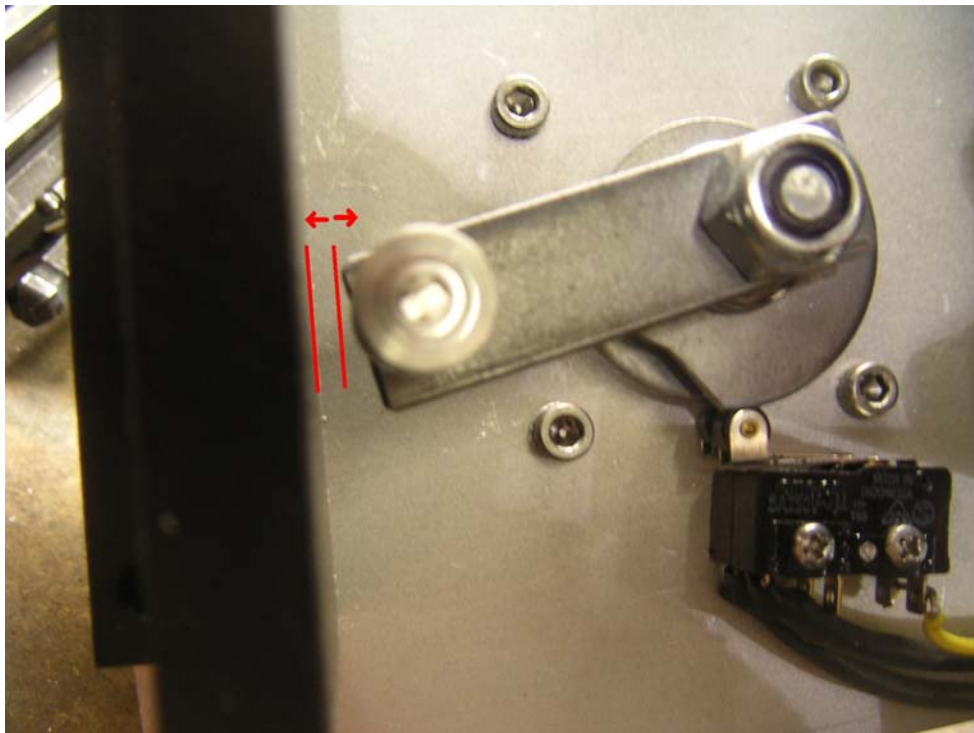

The switch is adjusted with the screws shown below. You should not have to adjust this as they were properly adjusted prior to shipment. The screw circled in blue is a pivot point and the actual adjustment is made using the switch on the left (circled in red). You may need to loosen the nut on the back of the unit to properly adjust the switch.

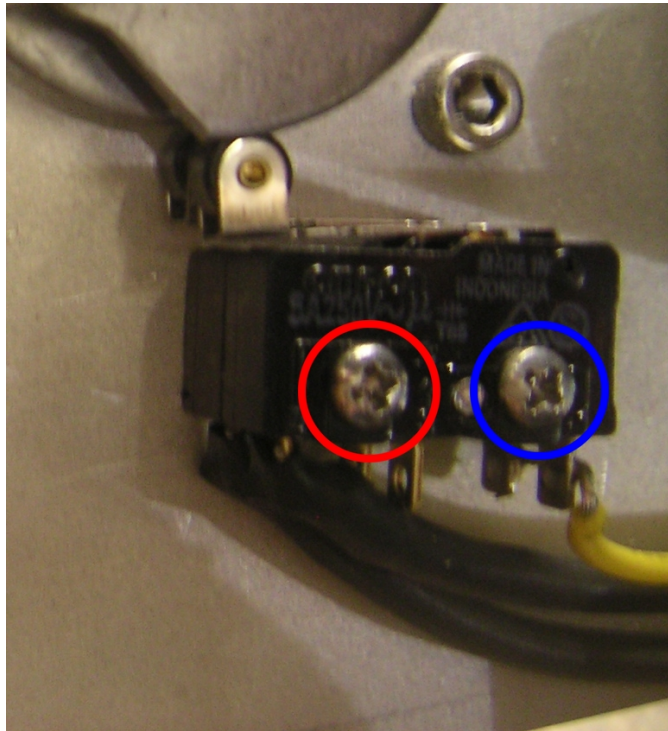

CAM ADJUSTMENTS

The cam assembly was pre set at assembly for optimum performance. Should the need to move or disassemble the unit arise, please refer to the picture below for reassembly. The software in Earthshaker looks for certain switches at certain times. Improper setting can cause erratic behavior.

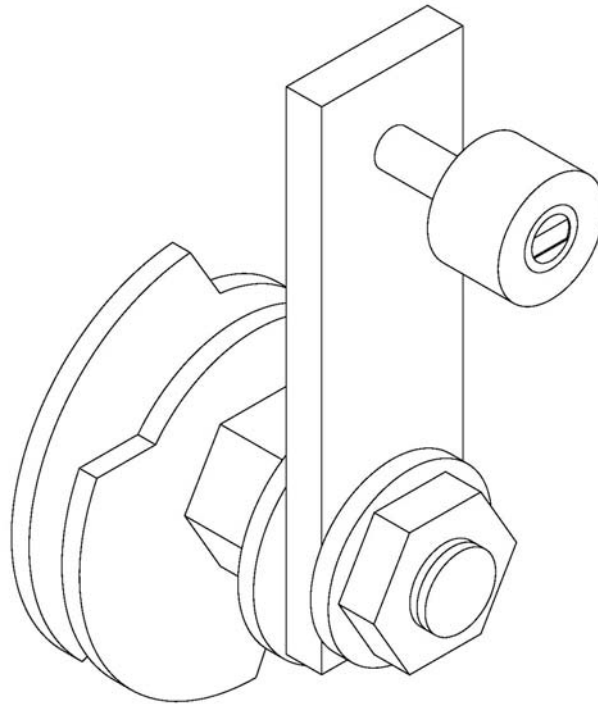

THEORY OF OPERATION

The cam and switch closest to the motor stops the building at its lowest position. This takes place then this switch toggles from the on position to off. The cam closest to the building stops the building at the top position. This takes place then this switch toggles from the off position to on. These actions have a \pm tolerance of about 5 degrees. You may rotate the cams within this window if you do not like the stop position of your building in either position.

Appendix D – Matrix Changes

The original manual had the following differences:

EARTHSHAKER Switch-Matrix Table

ROW	COLUMN							
	1 Q45 GRN-BRN 1J8-1	2 Q49 GRN-RED 1J8-2	3 Q44 GRN-ORN 1J8-3	4 Q48 GRN-YEL 1J8-4	5 Q43 GRN-BLK 1J8-5	6 Q47 GRN-BLU 1J8-7	7 Q42 GRN-VIO 1J8-8	8 Q46 GRN-GRY 1J8-9
1 WHT-BRN 1J10-9	Plumb Bob Tilt 1	Playfield Tilt 9	Left Outlane 17	Building Height 1 25	On Ramp 50K 33	Spinner 41	49	Flipper Right 57
2 WHT-RED 1J10-8	C Side Power A/C Relay 2	Outhole 10	Left Return Lane 8 18	Building Height 2 26	On Ramp 25K 34	Fault Open 42	Ball Shooter 50	Flipper Left 58
3 WHT-ORN 1J10-7	Credit Button 3	Ball Trough #1 (R) 11	Left Standup 1 19	3-Bank Drop Target (left) 27	On Ramp 100K 35	Right Ramp Entry 43	51	59
4 WHT-YEL 1J10-6	Right Coin Chute 4	Ball Trough #2 (Mid) 12	Eject Hole 5 20	3-Bank Drop Target (mid) 28	On Ramp Bypass 36	Center Ramp Entry 44	Left Jet Bumper 52	60
5 WHT-GRN 1J10-5	Center Coin Chute 5	Ball Trough #3 (L) 13	Right Standup (high) 2 21	3-Bank Drop Target (right) 29	Ball Popper (top) 37	Center Ramp Middle 45	Right Jet Bumper 53	61
6 WHT-BLU 1J10-3	Left Coin Chute 6	Right Inside Return Lane 7 14	Right Standup (low) 3 22	Center Standup 4 30	Under Playfield Drop Hole 1 38	Center Ramp End 46	Top Jet Bumper 54	62
7 WHT-VIO 1J10-2	Slam Tilt 7	Right Outside Return Lane 15	Captive Ball 9 23	Right Loop 6 31	Under Playfield Drop Hole 2 39	47	BL Kicker ("sling") 55	63
8 WHT-GRY 1J10-1	High Score Reset 8	Right Outlane 16	Right Standup (50K) 24	Left Loop 6 32	Ball Popper (bottom) 40	48	BR Kicker ("sling") 56	64

BL = Bottom Left BR = Bottom Right ○ ZONE Numbers

EARTHSHAKER Solenoid Table

Sol. No.	Function	Solenoid Type	Wire Color	Connections		Driver Trnstr	Solenoid Part Number Flashlamp Type d= Display Bd; p=Playfield
				CPU Bd	Playfield/Cabinet		
01A ³	Outhole Kicker	Switched	{ Vio-Brn }	1P11-1	5J1-9: 5J4-9 (A)	Q33	AE-23-800
01C ³	Captive Ball Flasher	Switched	{ Blk-Brn }	(Gry-Brn)	5J5-9 (C)	Q33	#89 flashlamp 1p
02A ³	Ball Release (Shtr Lane Feeder)	Switched	{ Vio-Red }	1P11-3	5J1-7: 5J4-8 (A)	Q25	AE-23-800
02C ³	Cntr Ramp 1 & Bldg Flashers	Switched	{ Blk-Red }	(Gry-Red)	5J5-8 (C)	Q25	#906/#89 flashlamps 2p
03A ³	3-Bank Dr Tgt Reset	Switched	{ Vio-Orn }	1P11-4	5J1-6: 5J4-7 (A)	Q32	AE-26-1200
03C ³	Cntr Ramp 2 & Spinner Flashers	Switched	{ Blk-Orn }	(Gry-Orn)	5J5-7 (C)	Q32	#906/#89 flashlamps 2p
04A ³	California Fault	Switched	{ Vio-Yel }	1P11-5	5J1-5: 5J4-6 (A)	Q24	AE-23-800
04C ³	Cntr Ramp 3 Flasher	Switched	{ Blk-Yel }	(Gry-Yel)	5J5-5 (C)	Q24	#906 flashlamp 1p
05A ³	Eject Hole	Switched	{ Vio-Grn }	1P11-6	5J1-4: 5J4-5 (A)	Q31	AE-26-1500
05C ³	Cntr Ramp 4 Flasher	Switched	{ Blk-Grn }	(Gry-Grn)	5J5-4 (C)	Q31	#906 flashlamp 1p
06A ³	Bottom Ball Popper	Switched	{ Vio-Blu }	1P11-7	5J1-3: 5J4-4 (A)	Q23	AE-24-900
06C ³	Right Ramp 1 Flasher	Switched	{ Blk-Blu }	(Gry-Blu)	5J5-3 (C)	Q23	#906 flashlamp 1p
07A ³	Knocker	Switched	{ Vio-Blk }	1P11-8	5J1-2: 5J4-2 (A)	Q30	AE-23-800
07C ³	Right Ramp 2 Flasher	Switched	{ Blk-Vio }	(Gry-Vio)	5J5-2 (C)	Q30	#906 flashlamp 1p
08A ³	Not Used	Switched	{ Vio-Gry }	1P11-9	5J1-1: 5J4-1 (A)	Q22	
08C ³	Right Ramp 3 Flashers	Switched	{ Blk-Gry }	(Gry-Blk)	5J5-1 (C)	Q22	#906/#89 flashlamps 2p
09	Building Motor (with Relay)	Controlled	Brn-Blk	1P12-1	5J2-9: 5J6-9: 2J4-3	Q17	14-7941-1 (5580-12145-01)
10	High Playfield Gnl Illum Relay	Controlled	Brn-Red	1P12-2	5J2-8: 5J6-8: 2J4-5	Q9	5580-12145-01 ⁴
11	Insert Board Gnl Illum Relay	Controlled	Brn-Orn	1P12-4	5J2-6: 5J6-7: 2J4-6	Q16	5580-12145-01 ⁴
12	A/C Select Relay	Controlled	Brn-Yel	1P12-5	5J2-5	Q8	5580-09555-01 ⁵
13	Top Ball Popper	Controlled	Brn-Grn	1P12-6	5J2-4: 5J6-5	Q15	AE-23-800
14	Jackpot & Sun Flashers	Controlled	Brn-Blu	1P12-7	5J2-4: 5J6-3	Q7	#906 flashlamps 2p
15	Low Playfield Gnl Illum Relay	Controlled	Brn-Vio	1P12-8	5J2-2: 5J6-2	Q14	5580-12145-01 ⁴
16	On Ramp & J Bumper Flashers	Controlled	Brn-Gry	1P12-9	5J2-1: 5J6-1	Q6	#906/#89 flashlamps 2p
17	Left Jet Bumper	Special #1	Blu-Brn	1P19-7	5J3-7: 5J7-7	Q75	AE-23-800
18	Left Kicker ("sling")	Special #2	Blu-Red	1P19-4	5J3-6: 5J7-6	Q71	AE-26-1500
19	Right Jet Bumper	Special #3	Blu-Orn	1P19-3	5J3-3: 5J7-3	Q73	AE-23-800
20	Right Kicker ("sling")	Special #4	Blu-Yel	1P19-6	5J3-4: 5J7-5	Q69	AE-26-1500
21	Top Jet Bumper	Special #5	Blu-Grn	1P19-8	5J3-2: 5J7-2	Q77	AE-23-800
22	Quake Motor	Special #6	Blu-Blk	1P19-9	5J3-1: 5J7-1	Q79	14-7951
-	Right Flipper	-	Orn-Vio	1P19-1	2J5-5: 2J10-7	-	
-	Lower Right Flipper	-	[Blu-Vio]	2	[2J10-1: 2J8-15]	-	FL11630/50VDC
-	Left Flipper	-	Orn-Gry	1P19-2	2J5-4: 2J10-8	-	
-	Lower Left Flipper	-	[Blu-Gry]	2	[2J10-2: 2J8-4]	-	FL11630/50VDC
-	Upper Left Flipper	-	[Blk-Blu]	2	[2J10-4: 2J8-12]	-	FL11722/50VDC

Notes: 1. Wire colors, except flipper Orn-Vio and Orn-Gry, are ground connections (to coil terminal with unbanded end of diode). Flipper Orn-Vio and Orn-Gry wires connect from CPU Board to flipper switch. 2. Flipper connections shown in braces are from flipper switch to flipper coil. 3. "A" circuits are pulsed, when Sol. 12 is de-energized; "C" circuits are pulsed, with Sol. 12 energized. Wire colors in brackets are those from respective A and C terminals corresponding to the J1-terminal connection listed for the Aux Power Driver Bd, which controls the device pulsing by Sol. 12. 4. Relay is mounted on Relay Bd, p/n C-11998-1. 5. Relay is mounted on Aux Power Driver Bd, D-12247 in the backbox.